

(G616) LG-13
Lathe Chuck Guard
Diagram

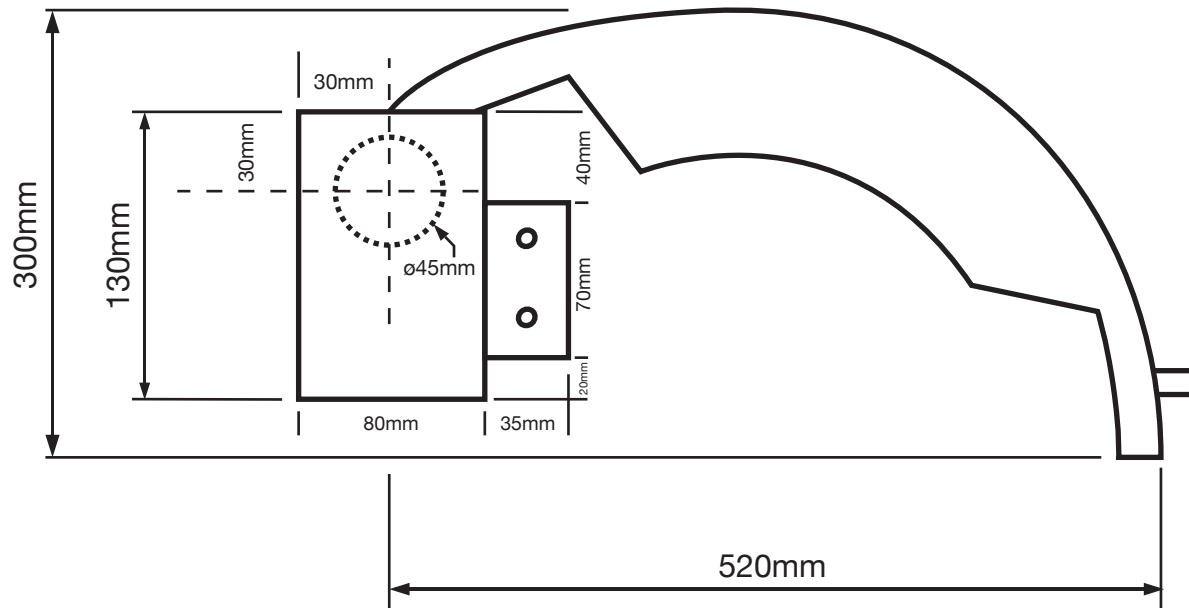
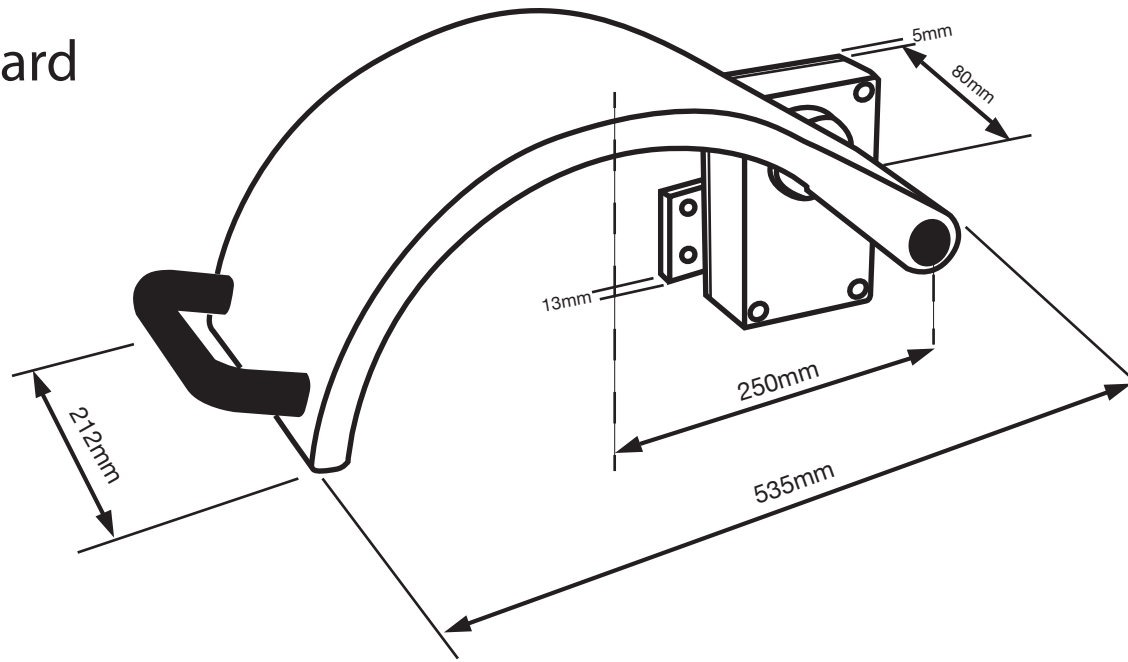

Diagram not to scale